



True Harmonics Solution

- Active Harmonics Compensation
- Improve Power Quality
- Easy Selection
- Minimum Heat-Loss during Operation
- Instantaneous Dynamic Response
- Flexible Up-Grading / Redundancy
- Various Capacity Ranges 25A to 1200A

Harmonics Pollution—

Harmonics pollution is an increasing problem which affects all power distribution networks in industrial, commercial, telecom and medical applications. Most of power converting equipment or facilities can generate harmonics current:

- Uninterruptible Power Systems (UPS)
- DC power systems/chargers
- Frequency converters
- AC/DC variable speed drivers
- Fluorescent lamps
- Welding machines
- Computers and peripherals

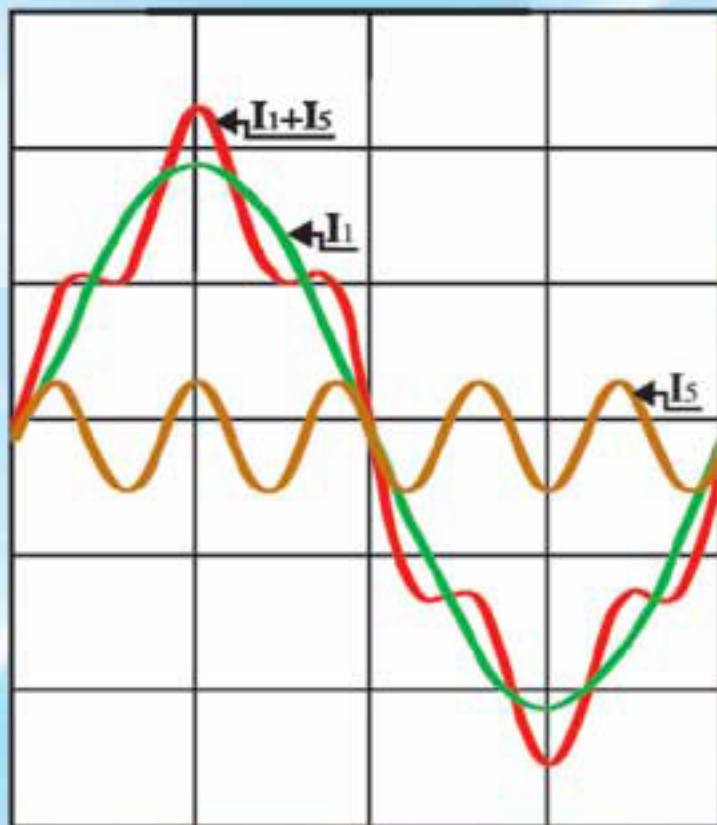

Enersine, the True Harmonics Solution—

Enersine, the true harmonics solution, is a solid-state power converter that brings about the following advantages to improve power quality:

- Eliminate all harmonic currents from non-linear loads
- Compensate reactive power factor of lagging loads
- Act as a virtual damping resistor to prevent possible harmonic resonance

Enersine APF behaves like a harmonics current generator. It will measure the harmonics generated from the non-linear loads and cancel these harmonics with a newly generated, opposite phase shifted harmonics current of the same amplitude.

Effects of Harmonics Pollution

The utility fundamental frequency waveform is either 50 or 60Hz. Harmonics are impure components with higher frequency order than that of the fundamental. For example, the 5th harmonic order is 250Hz, 5 times that of the 50Hz fundamental waveform. These impurities pollute the voltage/current waveform and deteriorate the power effectiveness of an equipment or system. Such deterioration will further lead to the following effects:

- Over voltage/current in the distribution network
- Over heated power cables due to skin effect and copper and iron loss in transformers, motors and generators
- Overheating in all types of electronics systems causing component failures
- Nuisance tripping in circuit breakers and protection relays
- Malfunction of automatic control systems
- Damage to capacitors due to resonance
- Inaccuracy of instrument measurement
- Interference in telecommunication systems
- Voltage distortion and lagging in power factor



Easy Selection

There is no need to measure the impedance of the power system or analyze the load harmonic spectrum and their individual amplitude. The selection is based on the known estimated load harmonics current amplitude (I_{Lh}) to be compensated, then select the Enersine APF model which has the output compensating current rating greater than that of the I_{Lh} . Generally as a rule of thumb, we recommend a 25% higher rating than the I_{Lh} to be compensated. For example, if the known load harmonics current amplitude is 80 Amps, the appropriate rating of the Enersine APF should be 100 Amps.



Case Study

Normally 3 phase large UPS with 6-pulse rectifier feedbacks heavy harmonics current of 30%~40% THD into Mains or emergency generator. It can cause line voltage distortion or generator malfunction. Enersine APF is well adapted to operate with large UPS to perform very low harmonic feedback, generating less than 5%.

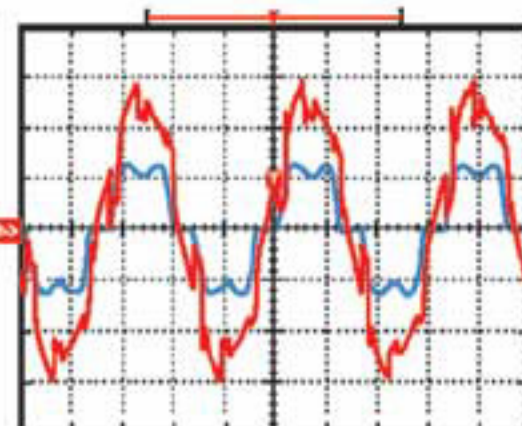
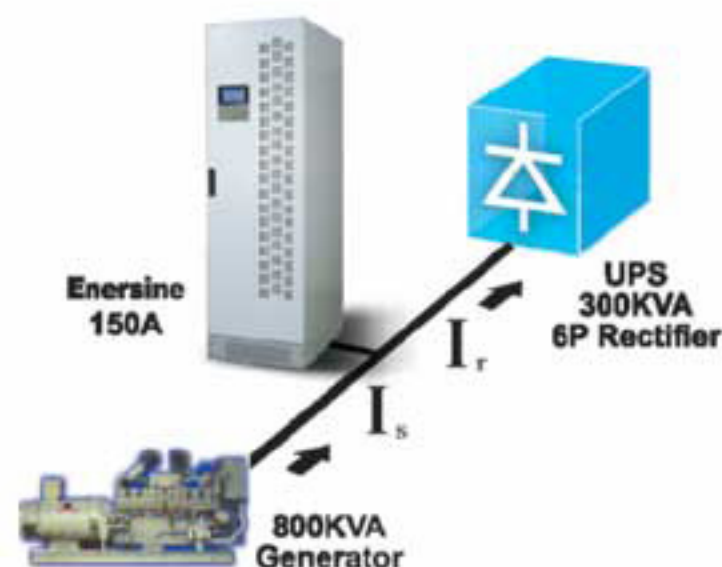

V & Is/Ir while Enersine off
THDV=17.4%

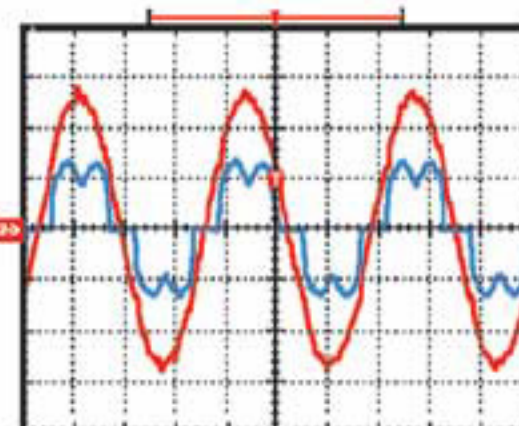

V & Ir while Enersine on
THDV=3.1%, THDIr=30.0%

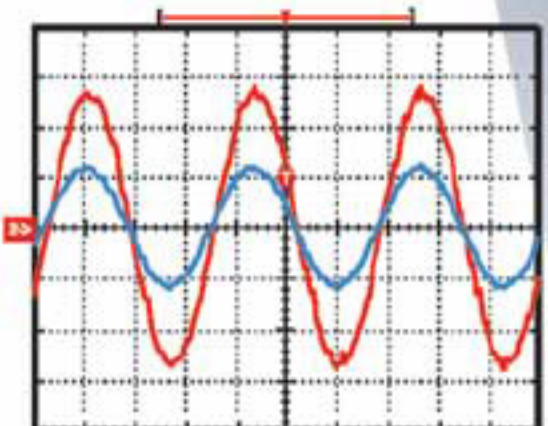

V & Is while Enersine on
THDI_s=2.5%

Minimum Heat-Loss during Operation

Thanks to its unique design, Enersine APF produces insertion losses of less than 3% and at full compensation, offering significant cost savings in energy. For example, the maximum heat-losses of Enersine 100A/380V is less than 2kW.

Instantaneous Dynamic Response

Enersine APF employs IGBT PWM converter switching at 20 kHz high frequency using advanced control techniques. It responds instantaneously to the dynamic variation produced by harmonic loads.

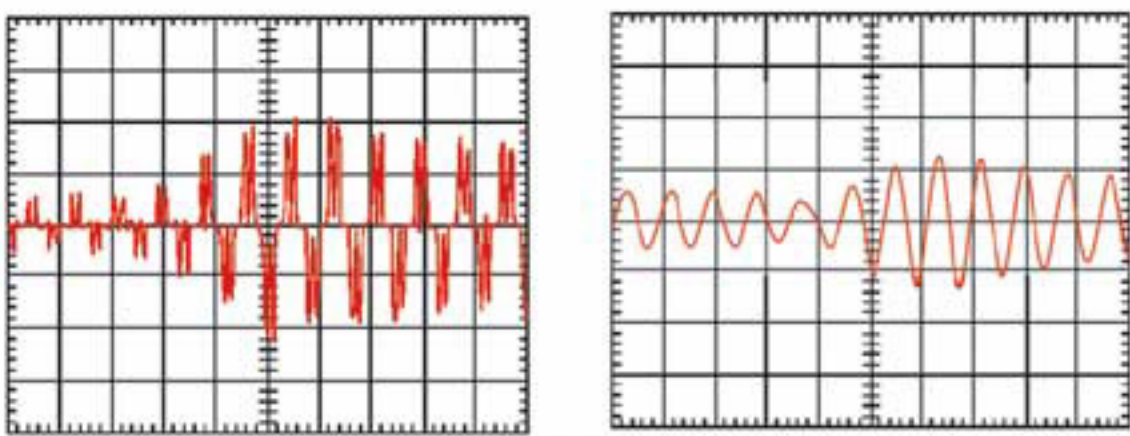

load current (before compensation) source current (after compensation)

Flexible Up-Grading Redundancy

In the event if the real values of the I_{Lh} is higher than the estimated one, or the I_{Lh} increases due to additional loads being added, there is no overload risk on the existing Enersine APF which have been selected. The Enersine APF has current-limit capability up to its full rating, thus it will not shut down or malfunction but will continue to operate in full compensating mode. Additional Enersine APF can be added in parallel on site later to meet the increment of the I_{Lh} values.

User-Friendly Control Panel

Enersine APF is equipped with a user friendly control panel. It is simple to turn the unit on or off and features buzzer silence and system status from 4 LEDs including Power On, Filtering, Full Correcting, & Error.

The optional LCD panel with special blue back light offers access to all parameters, waveforms, & spectrums for management of both Enersine and system power quality. The graphic LCD display & control panel gives easy access for load, source, & Enersine:

- ✔ Complete with V, I, F, PF, kVA, THD parameters
- ✔ Waveforms & harmonics spectrum
- ✔ Control commands & settings
- ✔ Status & alarms
- ✔ Events log



Voltage Free Contacts

Enersine APF comes with standard 3 voltage free contact signal outputs for easy monitoring:

- ✔ General Alarm
- ✔ Power On
- ✔ Filtering

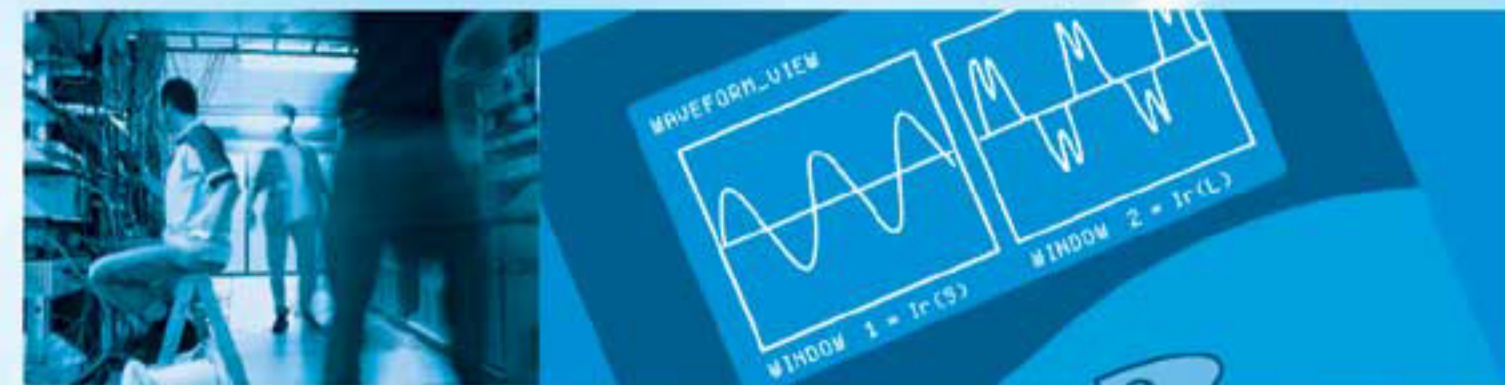

Optional Monitoring and Signaling

Enersine APF provides optional advanced comprehensive communication interfaces:

- ✔ Serial port RS232/RS485
- ✔ Ethernet network RJ45



General Characteristics

Equipment storage temperature	-20°C to +70°C
Operating Temperature	+12°C to +25°C (Recommend Range) , + 0°C to +40°C (Tolerate Range)
Relative Humidity	< 95%
Operating Altitude	< 1000 m
Reference Harmonic Standard	EN 61000-3-4 , IEEE 519-1992
Reference Design Standard	EN60146
Safety Standard	EN50178
Electromagnetic Compatibility	EN55011, EN50081-2, EN61000-4-2, EN61000-4-3, EN61000-4-4, EN61000-4-5, EN61000-4-6, EN61000-6-2

Electrical Specification

Category	Unit	25A	50A	100A	150A	200A
Line Voltage	V	208/400/480 ± 15%				
Phase/Wires		ES33 series for 3 phase 3 wires, ES34 series for 3 phase 4 wires				
Frequency	Hz	50/60 ± 3				
Compensating Current in Phase	Arms	25	50	100	150	200
Compensating Current in Neutral (1)	Arms	75	150	300	450	600
Transient Response Time (2)	msec	< 1				
Inrush Current		Less than rated current				
Current Limitation		Yes, at full correcting				
Soft Start	Sec	10				
Heat-loss	Watt	550	950	2000	3000	4100
Audible Noise from 1 Meter	dBA	60	60	63	63	65

Mechanical Specification

Category	Unit	25A	50A	100A	150A	200A
Color		RAL9001				
Protection Index		IP20				
Dimensions (W x D x H)	ES33 series	410 x 390 x 880		600 x 810 x 1930		1200 x 810 x 1930
	ES34 series	490 x 400 x 920		700 x 810 x 1930		1400 x 810 x 1930
Weight	ES33 series	55	70	230	260	430
	ES34 series	60	75	270	300	540

(1)Applicable for ES34 series only.

(2)The total time from detection to steady compensation at 100% load step is less than 40 msec.

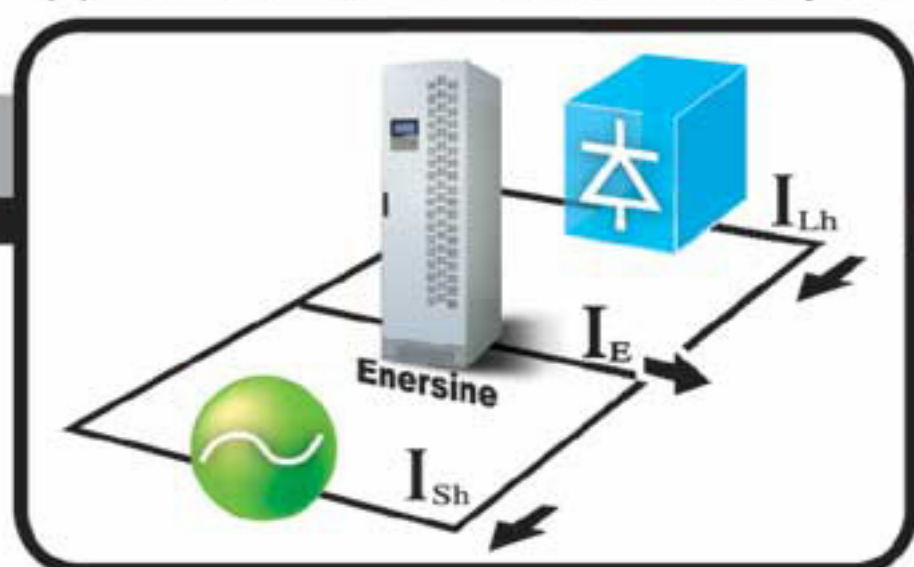

Harmonic Attenuation Ratio

The compensation ability of the Enersine APF is defined in terms of Harmonic Attenuation Ratio (HAR, I_{Lh} / I_{Sh}). Typically it is greater than 10.

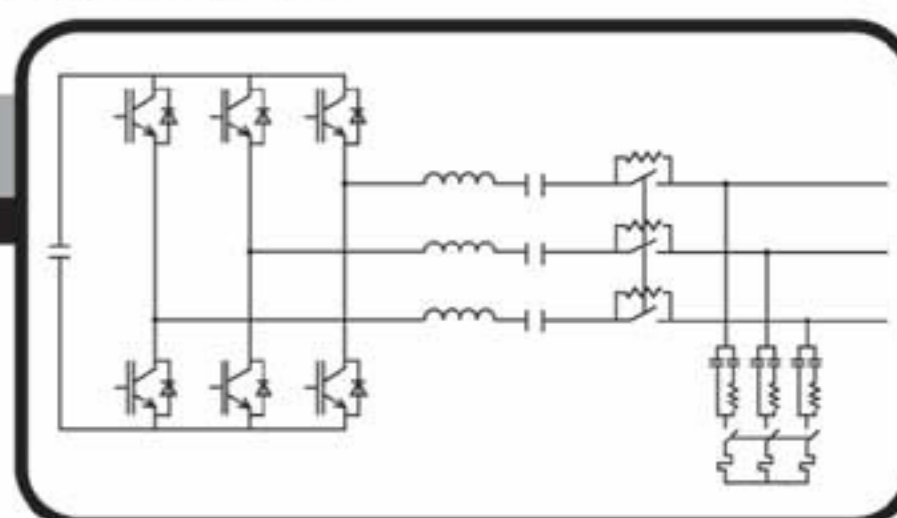

Architecture of Enersine

Enersine APF provides 3 phase harmonic current compensation, and the main components of the APF are as follow:

- ▀ Ripple Current Filter Module
- ▀ Electromagnetic Contactor Module
- ▀ High Frequency Inductor-Capacitor Module
- ▀ IGBT Power Converter Module
- ▀ DC Capacitor Module

Designed & Engineered by



Offices:

Ablerex Europe s.r.l.
Strada Marosticana 81/15
36031 Povolara (VI) ITALIA
Tel: +39 0444 361321 / +39 0444 365668
Fax: +39 0444 385191

UIS Abler Electronics (S) Pte Ltd
16 New Industrial Road #02-04
Hudson TechnoCentre Singapore 536204
Tel: +65 6282 6535 Fax: +65 6282 6343
Email: sales@ablerex-ups.com.sg
<http://www.ablerex-ups.com.sg>